

WN 054850 45532
10/08

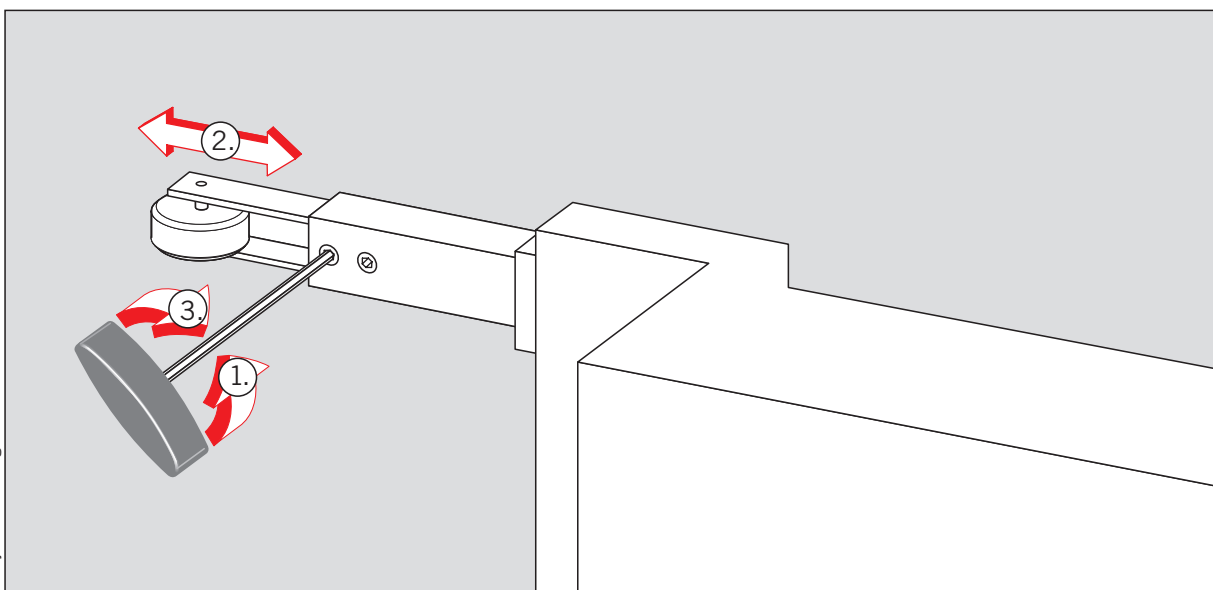
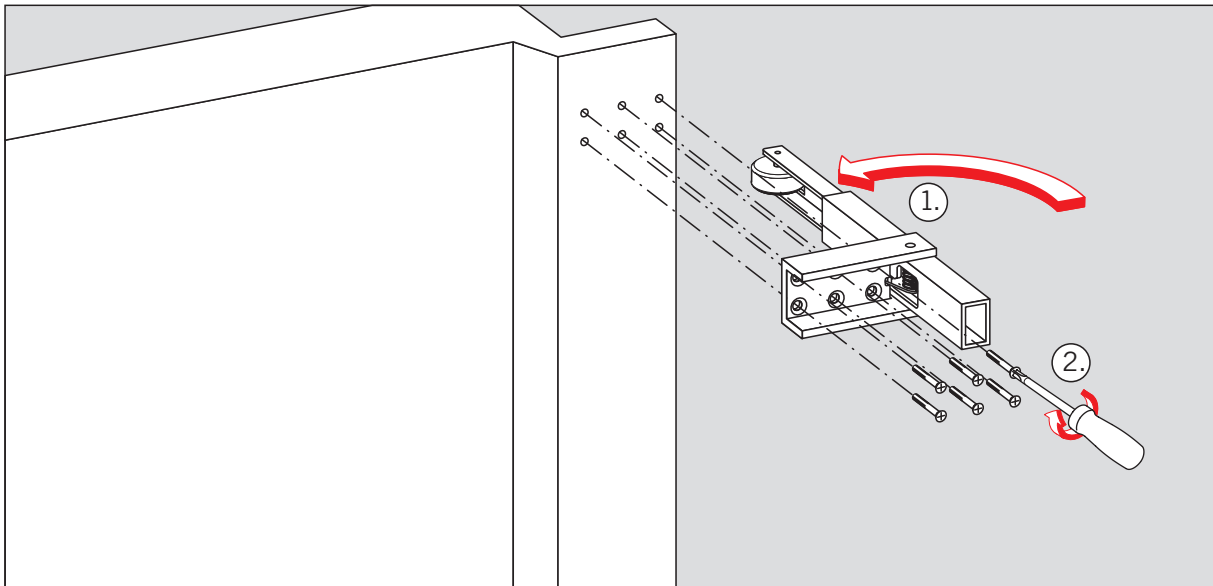
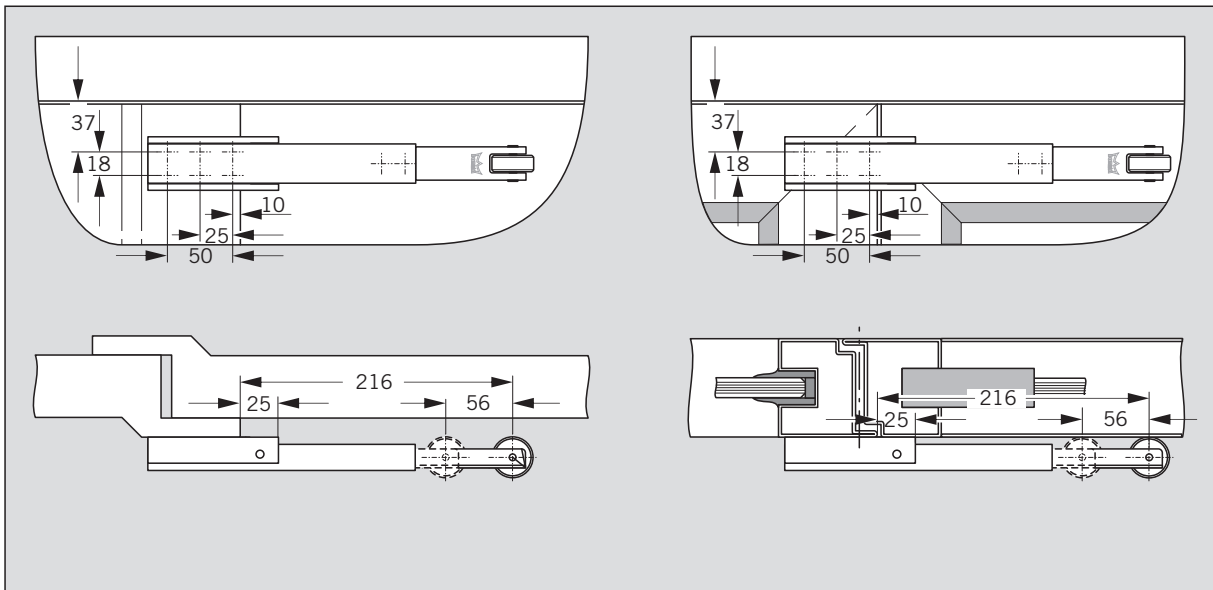

Änderungen vorbehalten
Subject to change without notice